

Children's Educational Materials
Bible STUDY
292

Number
13

THE REVIVAL BROUGHT BY REVELATION

by Rev. Jose Benjamin Perez Matos
Friday, March 24, 2023
Cayey, Puerto Rico

The reference pages listed in the material are based on the **individual** study booklet:
<https://www.carpa.com/en/activities/march-24-2023-activity/>



www.carpa.com
www.escuelabiblicadeninos.com

Parents and/or Teachers:



We prepared this educational material with dynamics and activities in order to provide you with a resource to supplement the Bible Studies given by Reverend Jose Benjamin Perez Matos.



It is separated by page order (according to the selected Bible Study) and ages.



It is recommended that you download the Bible Study in booklet form directly from the page www.carpa.com and that you download the didactic material from the page www.escuelabiblicadeninos.com.



Once you have downloaded both materials, you can choose the dynamic or activity you wish, according to the age of your children.



The materials used in the different activities or dynamics are suggested; you can adapt them to your environment, available material and class time.



We are living in a time like the time in which Jesus turned the waters into wine.
We are living in a time for which there are great promises of a great revival, which will be greater than there have been in the history of the Church of the Lord Jesus Christ; but that it is typified, represented, in the one there was in the time of the apostles and in the one there was in the time of each angel messenger...

WORDS OF GREETING
(Ministers Meeting)

Dr. William Soto Santiago
Tuesday, April 25, 2006
(Second activity)
Torreon, Coahuila, Mexico

Today →

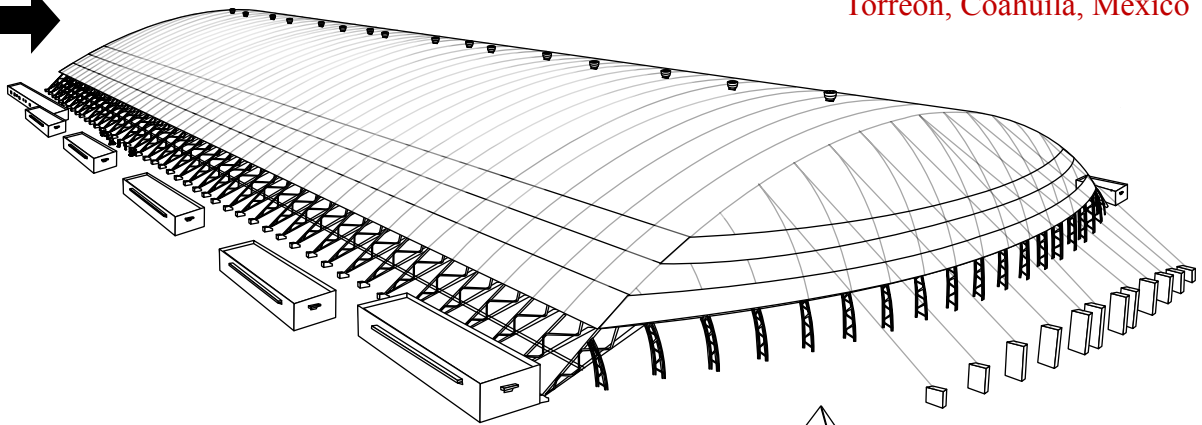

Type and figure
Time of the messengers →

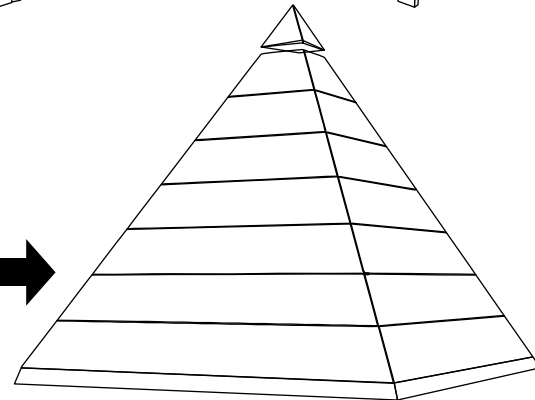

Type and
figure →





[WSS] «Each revival produces twins.

Abel and Cain; Jacob and Esau; David and Saul; Jesus and Judas».

*Cada Avivamiento produce Gemelos
Abel y Cain, Jacob y Esau, David y Saul, Jesus y Judas.* Jeffersonville, Ind., 12-5-60
individua
ministe

Color:

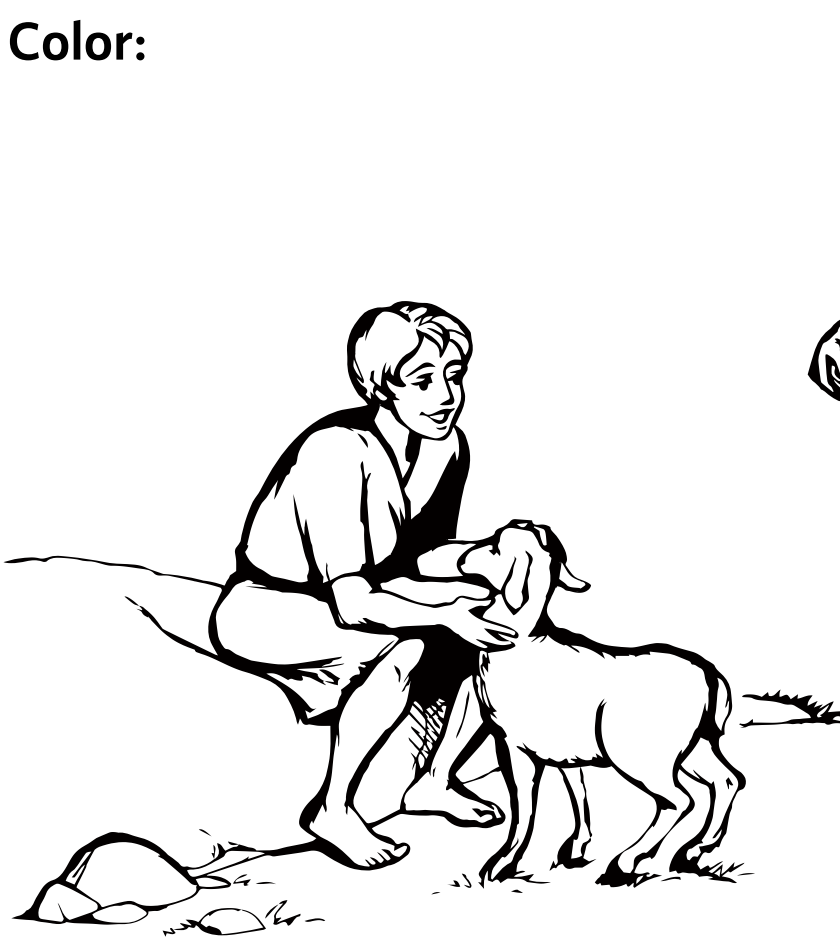

Abel



Cain

Search in your Bible to learn what happened in this story.

Genesis, chapter 4

Your name



[WSS] «Each revival produces twins.

Abel and Cain; Jacob and Esau; David and Saul; Jesus and Judas».

*CADA Avivamiento produce Gemelos
Abel y Cain, Jacob y Esau, David y Saul, Jesus y Judas.* Jeffersonville, Ind., 12-5-60 individua ministe

Color:



Jacob



Esau

Search your Bible to learn what happened in this story.

Genesis, chapter 25

Your name

*[WSS] «Each revival produces twins.
Abel and Cain; Jacob and Esau; David and Saul; Jesus and Judas».*

*Cada Avivamiento produce Gemelos
Abel y Cain, Jacob y Esau, David y Saul, Jesus y Judas.* Jeffersonville, Ind., 12-5-60 indivia ministe

Color:



David



Saul

Search your Bible to learn what happened in this story.

First Samuel, chapter 18.

Your name

[WSS] «Each revival produces twins.

Abel and Cain; Jacob and Esau; David and Saul; Jesus and Judas».

*CADA Avivamiento produce Gemelos
Abel y Cain, Jacob y Esau, David y Saul, Jesus y Judas.* Jeffersonville, Ind., 12-5-60
individua
ministe

Color:

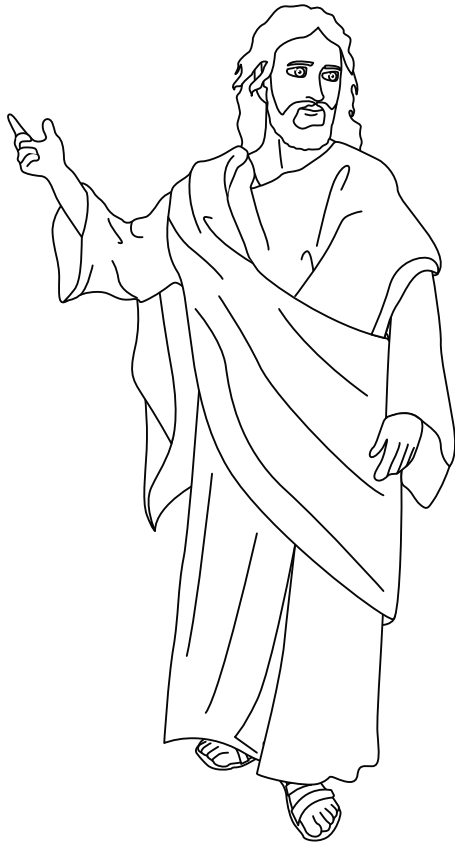

Jesus



Judas

Search your Bible to learn what happened in this story.

Matthew, chapter 26.

Your name

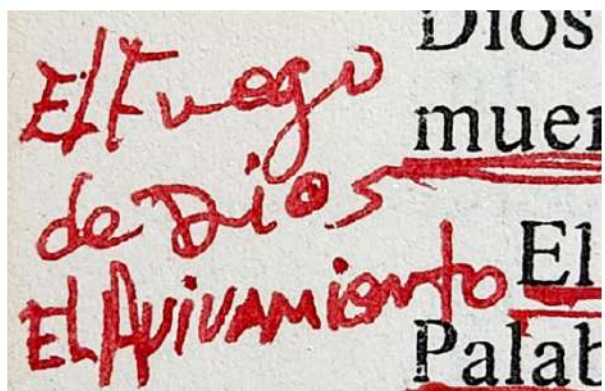

[WSS] «the Fire of God: the revival».

Color:



Your name

Activity: Do this activity on this page. In the heart diagram put all the phrases written by brother William Soto Santiago related to a spiritual revival, and in the diagram of the mind or brain put everything related or that pertains to a human (intellectual) revival.

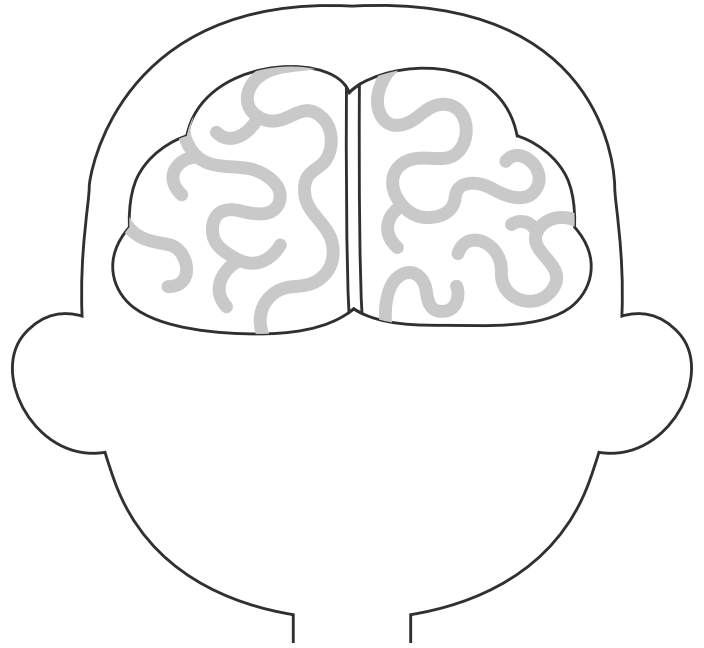
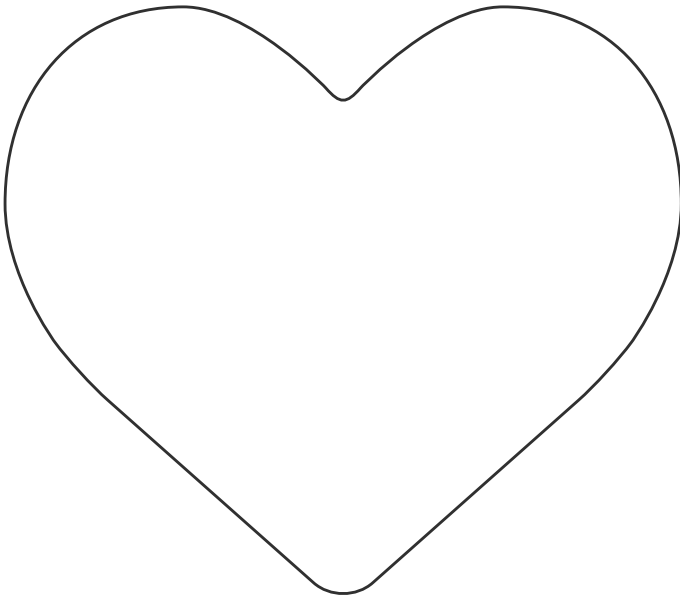

*in a man with a
ministry and a
Message [revealed]*

*the human one is through
a (their) denomination*

*they are members
of the Church of the
Lord Jesus Christ,
each one in his age
and dispensation*

*with (in)
denominational men*

*produces born again
sons and daughters
of God in and for the
Kingdom of God*

*and they produce more
denominational members
for their denominations*

*a revelation in the
midst of His Church*

*is through the
Holy Spirit*

What is a Revival?

We find throughout the Scripture many revivals that have happened. And what is a revival? A revival is the movement of God, the movement of God in God's power, it is a Divine movement manifested on this Earth, it is the way that God moves in the time in which one lives, it is the manifestation of the Work of God for that time.

And when a certain time comes for God to do something, then a revival emerges; and that revival is God's great manifestation, God's great movement to fulfill what He promised.

And when people enter that divine movement, they enter to receive God's blessing for that time. There is no other way to receive God's blessing, one must enter the divine movement for that time. And that divine movement is God's revival, God's revival for that time; and the people who go into that divine movement, are in a divine revival, and that divine revival produces those divine blessings, the divine blessings for that time.

The Revival / July 5, 1981 / Cayey, Puerto Rico

[WSS] «A man for a revival».



Illustration made by
 brother William Soto Santiago

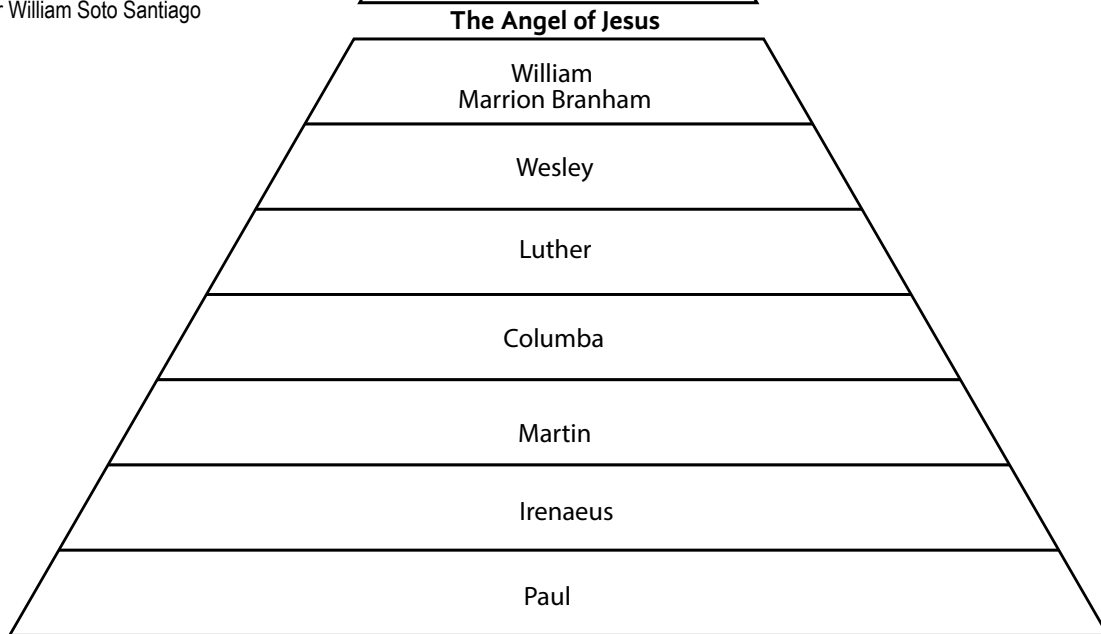
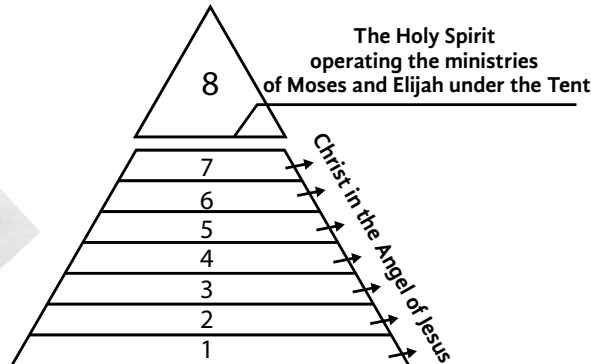

[WSS] «The difference there is between God's revival and a human revival: both run parallel to each other».

[WSS] «God's is through the Holy Spirit, in a man with a ministry and a Message [revealed] of God, a revelation in the midst of His Church; and produces born again sons and daughters of God in and for the Kingdom of God; and they are members of the Church of the Lord Jesus Christ, each one in his age and dispensation».

[WSS] «The human one is through a (their) denomination with (in) denominational men, and they produce more denominational members for their denominations».

[JBP] And that is the difference between a revival of God and a human revival, and he tells us that they run parallel.

Activity: Color and glue cotton on this flock of sheep with their shepherd, who represents the man that God will be using today in the midst of His Church bringing a revival.



Your name



[WSS] «but if it is not denominationalized, then the revival continues and the messenger is still alive, and the Church is like sheep with a shepherd».

*pero si no se Denomi-
naliza entonces el
avivamiento sigue
y el mensajero sigue
vivo y la iglesia es
como ovejas con
Pastor.*

[JBP] Notice how the revival continues, and the Church (the people) are not denominationalized because the messenger is still alive. That is not how it happened in the past ages.

In the Age of the Cornerstone, our brother William was telling us in a message, that that was not going to happen in the Age of the Cornerstone, because God would leave there the ministries of Moses and Elijah.

Answer:

What age are we in today?

Why won't this age be denominationalized?

What ministries will be in The Great Tent Cathedral today?

Your name



Color and cut along the dotted line, also make cuts along the dotted lines on the doors so that the woman on the stretcher can go in and come out.

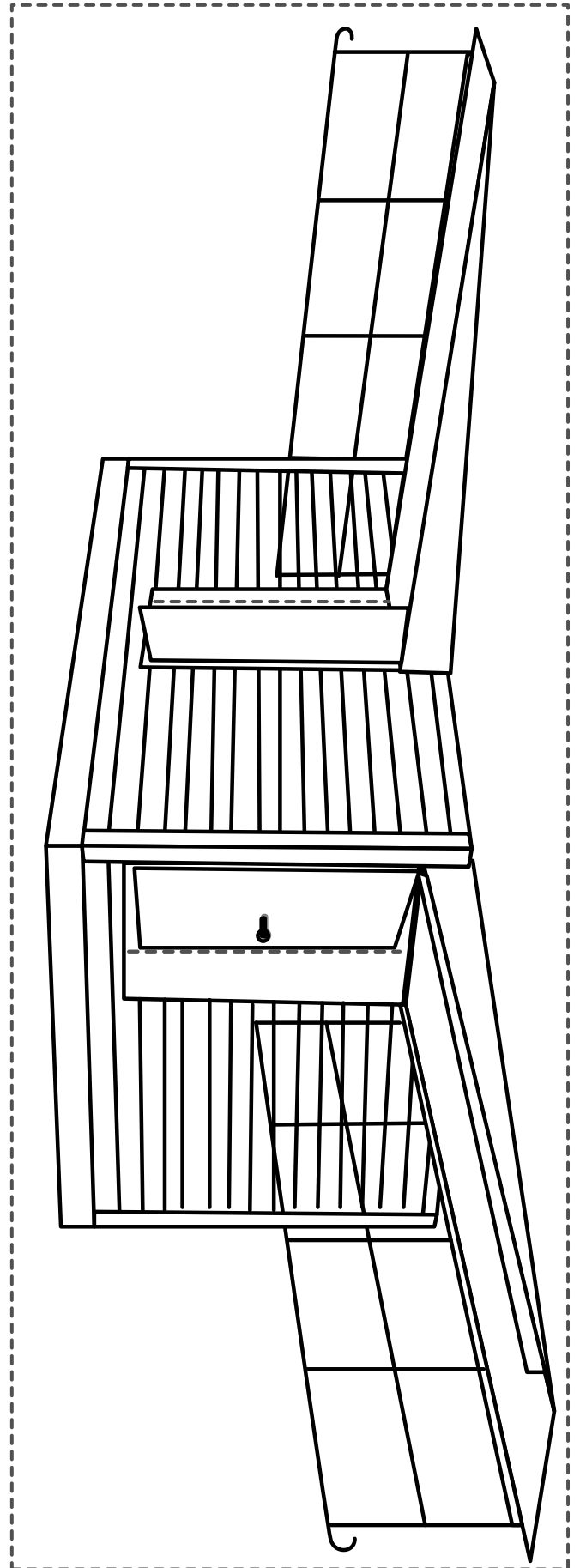
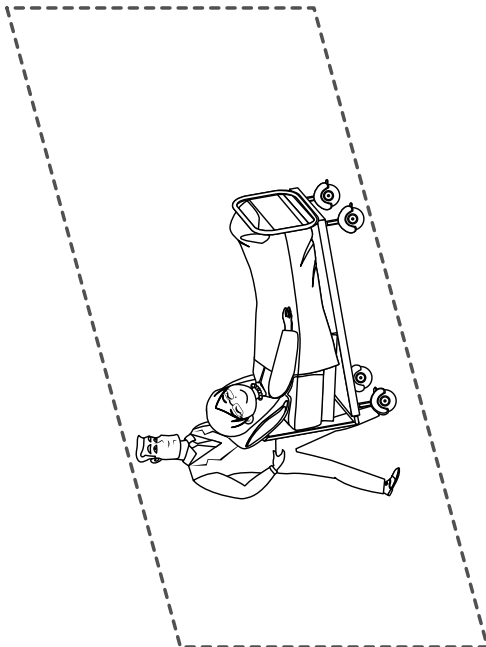
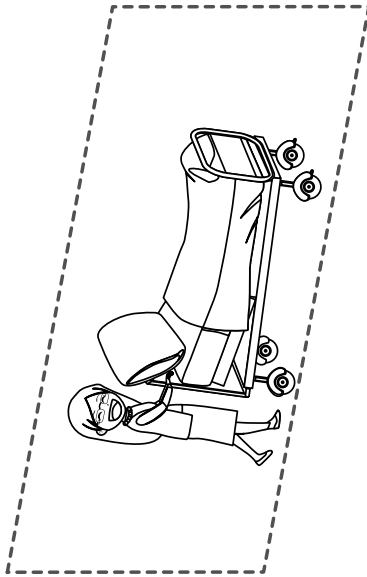

Color

[WSS] «The Tent.
«Reveal the meaning of the written words
of the Bible.» «Revival.»

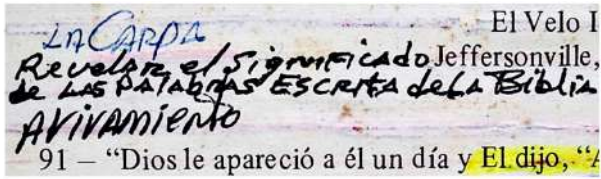

[WSS] «The Tent Vision and the miracles.»



[WSS] «in the Tent: a great gathering.»



[WSS] «The Tent Cathedral.»

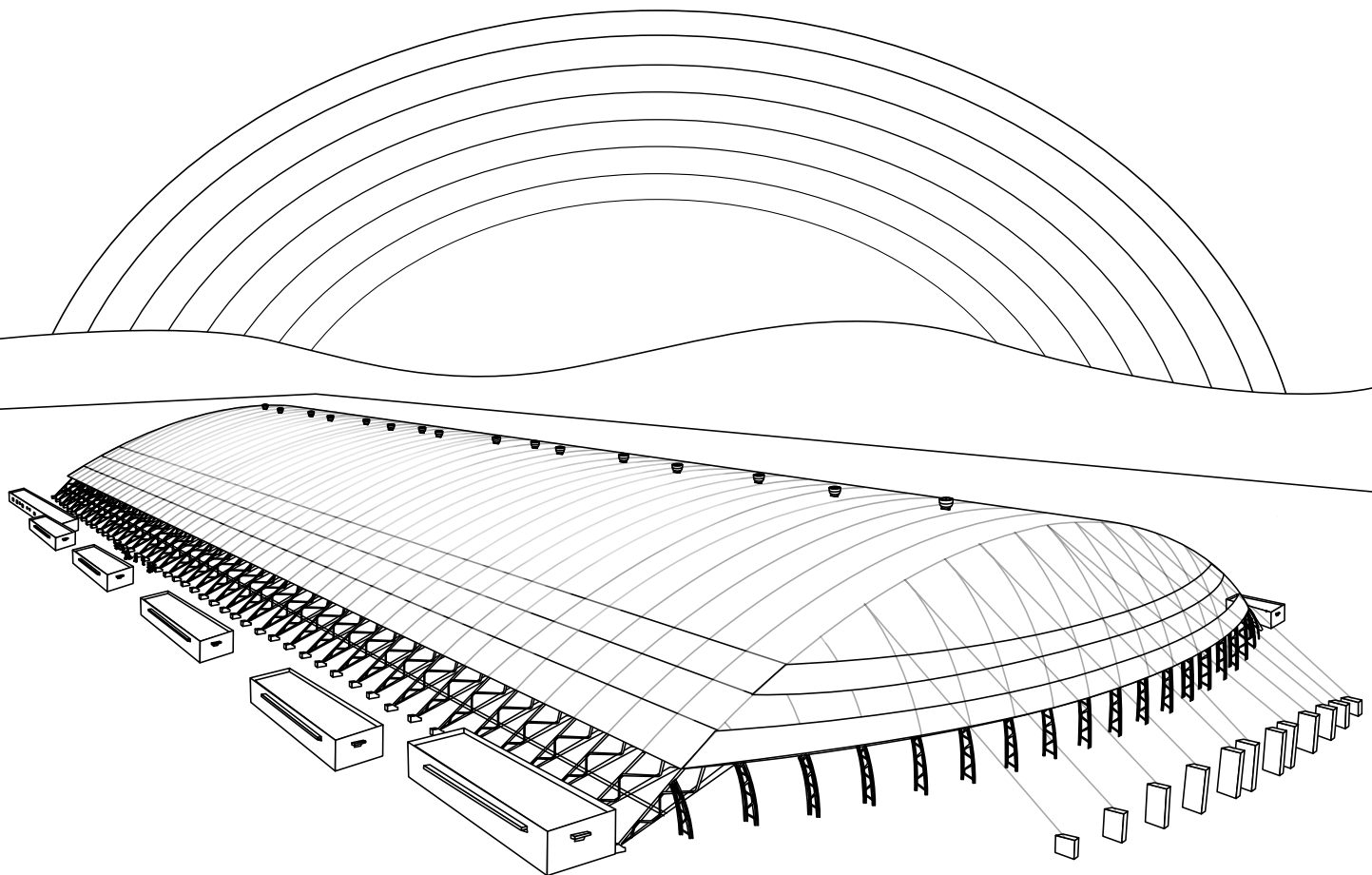
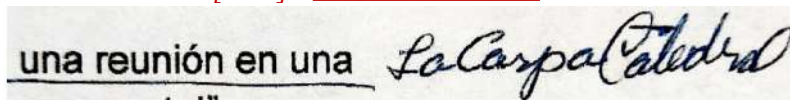

Your name



Choose the right answer

[WSS] «Each revival produces _____.

- a new stage
- twins
- joy

Abel and _____;

- Seth
- Cain
- the sacrifice

Jacob and _____;

- Esau
- Saul
- Naaman

David and _____;

- Esau
- Absalom
- Saul

Jesus and _____».

- The pharisees
- Judas
- the Caesar

[WSS] «Brother of the tribe of Judah, a type of _____»

- the apostles
- the family
- Judas Iscariot

[WSS] «The _____ trail».

- serpent's
- Word's
- truth's

[WSS] «The mark of the _____ =
organizations, denominations».

- hand
- forehead
- beast

[WSS] «The Tent Vision and the _____»

- 3 groups
- miracles
- believers

[WSS] «The _____ with Moses and Elijah».

- two witnesses
- elect
- miracles

The First Pull, _____;

- healing
- the Word
- believing

Second Pull: _____

- the Word
- believing
- prophesying

[WSS] «prophet»; Third Pull, the _____ of the
Word, the mysteries revealed.

- opening
- believing
- understanding

[WSS] «3rd Pull = the Seals».

«7 Seals / 3rd Pull = opening the Word = _____»

- by prophet
- the Message
- studying

[WSS] «in the Tent: a great _____».

- gathering
- Cathedral
- multitude

[WSS] «_____ produce a revival»

- The Thunders
- The songs
- The prayers

[WSS] «_____ are revival»

- rivers
- rains
- rocks

[WSS] «Ezekiel 37:1-15 is a _____».

- spiritual revival
- literal valley
- group of people

Your name